

TCP-A10

User Manual

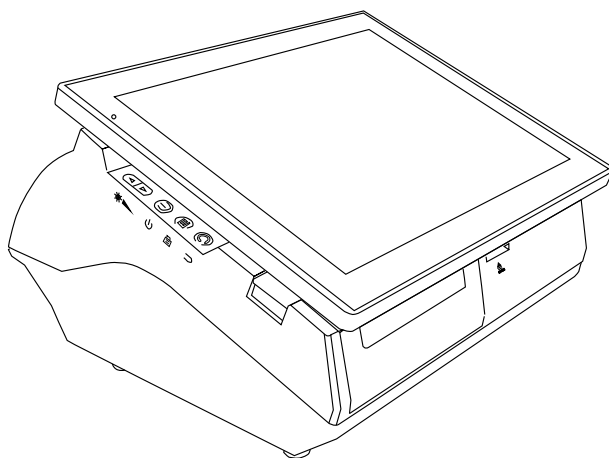

Dear customer,
Thanks for choosing our products. Following is all the items
you can find in your package.

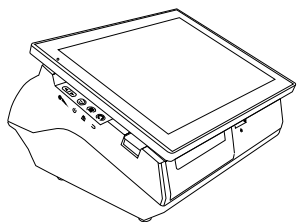

1. TCP-A10

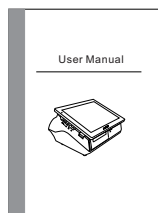

2. User manual

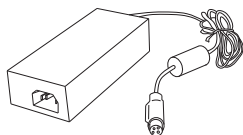

3. Adapter

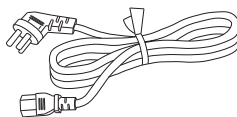

4. Power cable

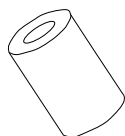

5. Roll paper

Introduction

A letter to customer

- Personal safety is important when operating and maintaining. Please read all safety warnings and cautions included in this manual carefully before operating and maintaining.
- Do not maintain the device by yourself, if you meet any faults can not be resolved under the instructions in this manual, please turn off power and pull out plug, contact us to get help.

About

This is an user manual to Android TCP-A10.

Safety statement

The contents of this manual only apply to this device, all contents have been validated and reviewed.

The contents are subject to change without notice.

Warranty statement

Device must be opened by original factory person or qualified service person. Do not maintain device by yourself, otherwise warranty will be invalid.

Trademark statement

All copyrights reserved by Code Soft.

1. Size

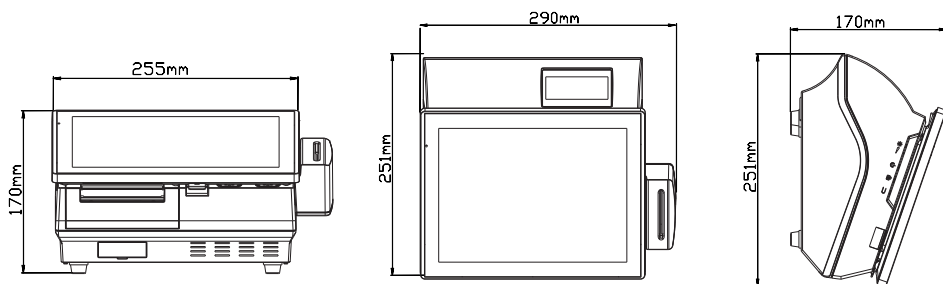

2. LED and buttons

2.1 Diagram

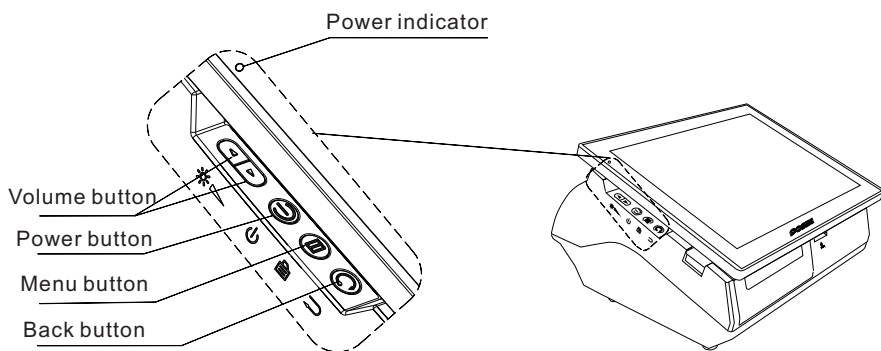

2.2 Description

	Description
LED indicator	Shows power status. Blue color when power is on.
Volume button	For adjusting speaker volume
Power button	Long press 8 seconds to turn on power, press 3 seconds to force shutdown
Menu button	Corresponding to Android menu button
Back button	Corresponding to Android back button

3.3 PIN definitions of cash drawer interface



Warnings

- This interface is only allowed to cash drawer, do not connect with telephone or others, otherwise will damage the telephone and your device.
- The working voltage of the cash drawers should be 24V.

The interface is standard RJ-11, 6 pins socket, output DC 24V/1A.

Following is the definitions:

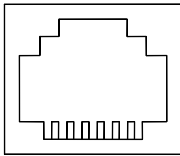

654321

RJ-11

PIN No.	Signal	Flow
1	Ground	Null
2	Cash drawer drive 1	Output
3	Cash drawer switch	Input
4	+12V/+24V	Output
5	Cash drawer drive 2	Output
6	Ground	Null

4. Installation



Notice

Take your notice of followings during installation. Otherwise may cause a fire, electric shock etc.

- Remove the screen film slowly to avoid static electricity which may damage the touch screen.
- Avoid placing in following circumstances:
 - * Sunlight * Dust * High temperature, humidity
 - * Excessive shock * Temperature changes frequently
- Keep away from magnetic and electromagnetic fields.
- Keep away from fire.
- Place on a flat, stable surface.

4.1 Reserved space

Make sure to reserve 80mm space around the device for cooling, in case vents blocked to damage the device

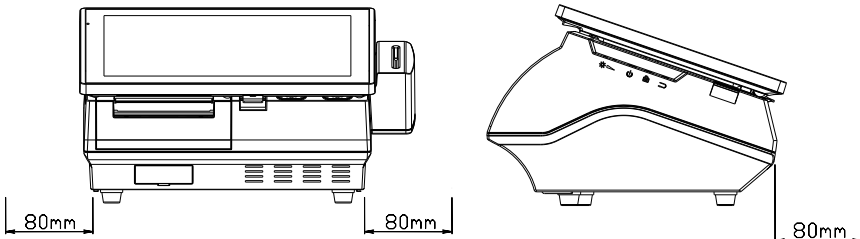

4.3 Install and replace card reader

Notice

- Do not pull cable.
- Avoid pressing on cable when installing card reader.

Follow below steps to install or replace a card reader:

- ① Remove side cover;
- ② Get the cable inside and plug into card reader;
- ③ Put cable inside carefully, fix card reader with screws.

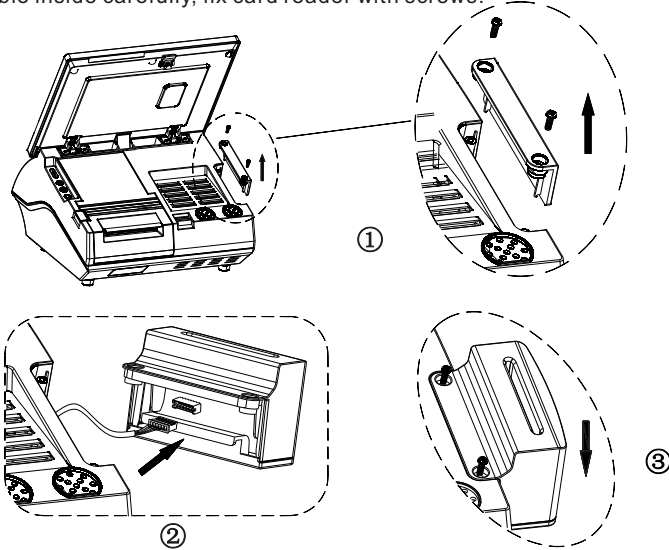

4.4 Install adjustable stand

4.4.1 Put device upside down on a flat surface, insert the stand as per image ①;

4.4.2 Push the stand to lock as per image ②.

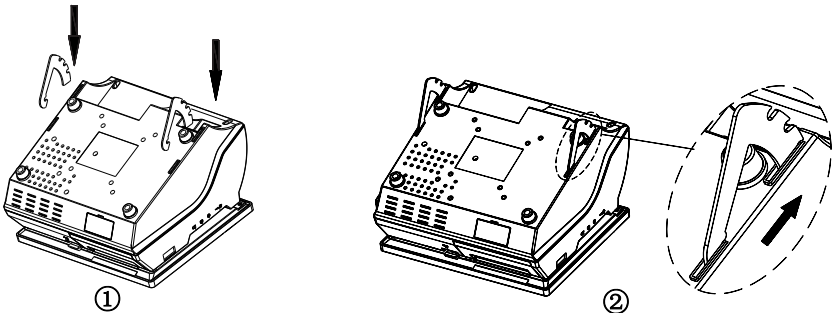

4.5 Connect power cable



Notice

- Make sure the power cable is not energized before connecting.
- Follow following diagrams, do not plug by force.

Plug in the power cable as per direction in following diagrams.

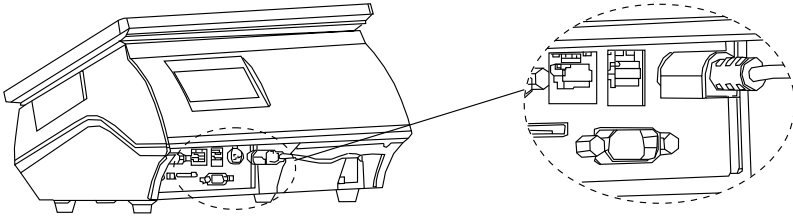

5. Viewing angle adjustment

Use the stand to adjust viewing angle. Optional angles include 19° , 24° , 29° , 33° .

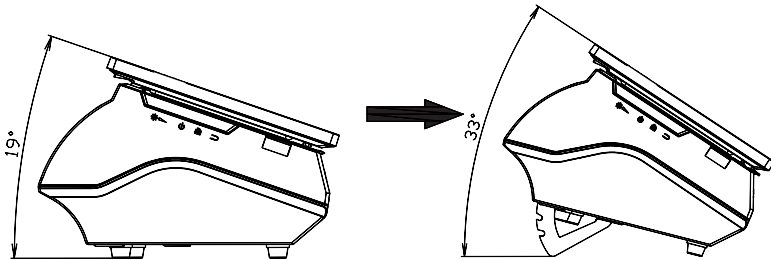

6. Volume adjustment

Volume button is on the left under the screen. Press up button to increase volume; press down button to decrease volume.

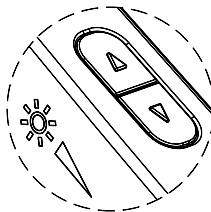

7. Troubleshooting

Can not start device, power indicator off.

- ① Check whether power socket works.
- ② Check whether power cable plugs tightly.

Printer keeps beeping, fails to print.

- ① Check whether the covers close well.
- ② Check whether roll paper used up.

Receipt is printed unclearly.

- ① Turn off power, swab print head and roller with medical alcohol.
- ② Repeat step ①, at the same time check whether printer cover can be closed tightly.

Printer cutter locked.

Restart the device, cutter automatic reset.

Printer cutter can not automatic reset.

If printer cutter locked and can not automatic reset, open cutter cover as per left diagram, turn the gear until cutter reset.

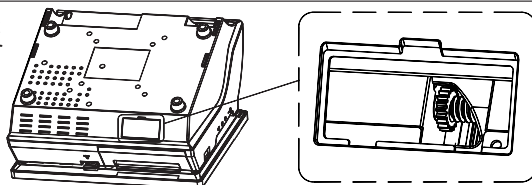

8. Maintenance

- ① Keep device far from sunlight, dust and water etc;
- ② Keep far from electromagnetic field;
- ③ In area of poor electronic power quality, it should be provided with separate regulated power supply.
- ④ Do not shake or knock device;
- ⑤ Do not plug in or out any parts in charged state. Do not move device frequently and disassemble internal components.
- ⑥ Keep device clean. Do not wipe body with wet cloth or chemicals.
For example: gasoline, thinner etc.
- ⑦ Turn off the power immediately once any faults happened. Do not disassemble and maintain by your own, contact us to get help.
- ⑧ Check regularly whether any cable loose.
- ⑨ Unplug all cables if will not use for a long time.
- ⑩ Do not restart system until one minute after shutting down, do not restart frequently.